

# Operator's Manual

**Save This Manual** Keep this manual for the safety warnings and precautions, assembly, operating, inspection, maintenance and cleaning procedures. Write the product's serial number in the back of the manual near the assembly diagram (or month and year of purchase if product has no number). Keep this manual and the receipt in a safe and dry place for future reference.

# AOTOWO

## 12V BATTERY POWERED

## ELECTRIC WINCH

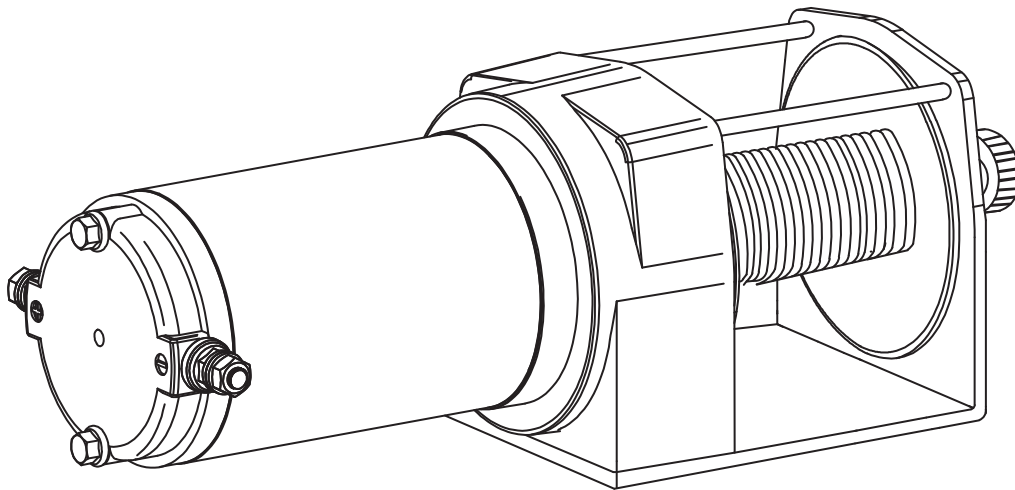

Visit our website at: <https://www.aotowo4x4.com>

### **⚠ WARNING**

Read this material before using this product.  
Failure to do so can result in serious injury.  
**SAVE THIS MANUAL.**

When unpacking, make sure that the product is intact and undamaged. If any parts are missing or broken, please contact us: [www.aotowo4x4.com](https://www.aotowo4x4.com).

No portion of this manual or any artwork contained herein may be reproduced in any shape or form without the express written consent. Diagrams within this manual may not be drawn proportionally. Due to continuing improvements, actual product may differ slightly from the product described herein. Tools required for assembly and service may not be included.

<b>SPECIFICATIONS</b> .....	1	<b>PARTS LIST</b> .....	8
line pull .....	1	<b>DIAGRAM</b> .....	8
<b>SAFETY</b> .....	2	<b>TROUBLESHOOTING</b> .....	9
Precaution .....	3	<b>MAINTENANCE</b> .....	10
<b>INSTALLATION</b> .....	4	Cleaning .....	10
Important Safety Information .....	4	<b>OPERATION</b> .....	11
Installation procedure .....	5	Clutch Operation .....	11
Set up .....	6	Double Line Rigging .....	12

# SPECIFICATIONS

Single Rated Line Pull	4,500 lbs	Battery Leads	8 Gauge
Application	ATV/UTV	Solenoid Leads	8 Gauge
Motor	12V DC 1.3 HP	Net Weights	26.6 lb
Mini Rocker Switch	12 feet Remote Switch	Overall Dimensions	14.6 x 4.6 x 4.8 inches
Gear Train	3-Stage Planetary	Mounting Bolt Pattern	4.88 x 2.3 inches
Gear Redction Ratio	166:1	Mounting Bracket	7.4 x 5 x 6.5 inches
Duty Cycle Rating	5% (45s at Max Rated Load, 15s Rest)	Mounting Hardware	Winch bolts (4 sets): M8-1.25 x 35mm Fairleads (2 sets): M8-1.25 x 20mm
Drum Size	Diameter 1.9 inches Length 3.3 inches	IP Rating	IP 66
		Sound Rating	85 dB
Fairlead	Aluminum Hawse Fairlead	Clutch Type	Turn Dial
Hook	5/16 inches	Braking	Action Automatic In-The-Drum
Wireless Remote	82ft	Synthetic Rope	1/4 inches x 50 feet
Battery	Recommended 650 CCA	Clutch	Sliding Ring Gear

Line pull	lbs	0	3000	3500	4000	4500
Line Speed	ft/min	19.2	11.2	10.7	9.9	8.5
Motor	Amps	55	97	115	128	150

Note: Specifications are approximate and subject to change

# WARRANTY

Electical components covered by the 1 year Limited Warranty:  
motor, contactor, solenoid, handheld remote controls.

All other mechanical components are covered by the Limited Lifetime Warranty.



**DANGER** Indicates an imminently hazardous situation which, if not avoided, will result in death or serious injury.



**WARNING** Indicates a potentially hazardous situation which, if not avoided, could result in death or serious injury.



**CAUTION** Indicates a potentially hazardous situation which, if not avoided, may result in minor or moderate injury. This notation is also used to alert against unsafe practices.

**Note:** Indicates additional information in the installation and operation procedures of your winch.

Correct installation of your winch is a requirement for proper operation.

Please Note: Winch is designed primarily for intermittent applications. This winch is not designed to be used in industrial or hoisting applications and we do not warrant it to be suitable for such use.

Never use winch to lift or move people.

Never use winch to hold loads in place.

Detailed mounting instructions for your specific vehicle are provided with each mounting kit. Read and follow directions carefully.



**CAUTION** This winch must be mounted with the rope in the under wound direction ( Fig. 1 ) Improper mounting could damage your winch and void your warranty.

Fig.1

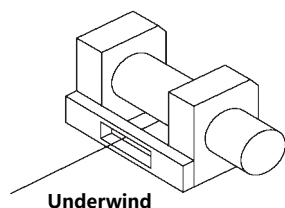

Underwind

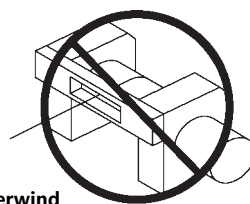

Overwind













**Note:** It is possible and not uncommon or discouraged to mount your winch in attitudes other than those shown in this installation manual. While mounting attitude is at your discretion, always remember that your winch is to operated with the rope in an under wound orientation on the rope drum ( Fig. 1 ) Your winch is designed to ROPE IN and ROPE OUT in one direction. Do not attempt to reverse the operation of your winch.



**CAUTION** Do not mount winch inverted, (base upward) or put the winch mounting hardware in direct tension condition. In all installations, the unit must be mounted so that the rope feeds through the hawse or roller fairlead on the front of the winch and does not rub across housings.

For winch capacities, a complete parts list and an exploded diagram of your specific winch, refer to the Technical Data Sheet included in this package.

For instructions on safe winch operation and tips for prolonging the life of your winch, refer to the User's Guide included in this package.

Symbol	Property or Statement
	<b>Wear heavy-duty, cut- and abrasion-resistant leather gloves.</b>
	<b>Wear ANSI-approved safety glasses.</b>
	<b>Cut or sever hazard.</b>
	<b>Roller entanglement hazard.</b>
	<b>Hot surface burn hazard.</b>
	<b>Fire hazard.</b>
	<b>Caustic chemical (acid) hazard.</b>
	<b>Explosion hazard.</b>
	<b>Do not loop the wire rope around object and hook onto itself.</b>
	<b>Do not place finger(s) through hook. Fingers may be caught and get pulled into fairlead or drum.</b>
	<b>Pull hook using strap only.</b>
	<b>Do not use winch in overwind orientation. (Wire rope enters/exits at the top.)</b>
	<b>Use winch only in underwind orientation. (Wire rope enters/exits at the bottom.)</b>



**WARNING! Read all instructions.**

**Failure to follow all instructions may result in fire, serious injury and/or DEATH.**

The warnings and precautions discussed in this manual cannot cover all possible conditions and situations that may occur. It must be understood by the operator that common sense and caution are factors which cannot be built into this product, but must be supplied by the operator.



1. Do not wear loose clothing or jewelry, as they can be caught in moving parts. Non-skid footwear is recommended. Wear restrictive hair covering to contain long hair.
2. Wear ANSI-approved safety goggles and heavy-duty leather work gloves during installation.
3. Before installation confirm that area is clear of fuel lines, brake lines, electrical wires, gas tanks or any other component which could be damaged during drilling.
4. Mounting location and hardware must support winch and load.
5. Use supplied power cords and wire rope listed in manual only. Do not use thinner/longer cables or link multiple cables together.
6. Do not route electrical cables near sharp edges or parts that will move or become hot.
7. Ventilate area well before and while working on battery. Explosive invisible hydrogen gas can accumulate and then explode when ignited by a spark from the battery connection.
8. Only connect to a clean, corrosion free battery.
9. Do not lean over or come in contact with battery while making connections.
10. Remove all metal jewelry before working near battery.
11. Connect red wire to positive battery terminal and black wire to negative battery terminal.
12. Insulate all exposed wiring and terminals after installation.
13. Install winch and fairlead in underwind orientation, so that the wire rope enters and exits the winch at the bottom of the drum.

### Step ( 1 )

Install mounting kit or prepare a flat, secure mounting location for winch to make sure the motor, drum, and gearbox are aligned correctly. Carefully follow the instructions included with the mounting kit.

**⚠ DANGER** Be sure structural support is strong enough to support rated capacity of the winch.

**Note:** If you choose not to use a mounting kit, you will need to drill holes in the structural support. Be sure that your structural support is at least 3/16" ( 5mm ) thick.

### Step ( 2 )

Position the winch over the holes in the mounting kit or structural support.

**⚠ DANGER** As you position the winch, make sure that the rope winds in the proper rotation on the drum. Your winch is intended to operate in one direction only. Failure to operate the winch in the proper direction can cause the winch brake ( if equipped ) to operate improperly, and/or cause the winch to fail.

### Step ( 3 )

Secure winch ( Fig. 2 ) to mounting kit or structural support using bolts, lock washers and square nuts supplied with winch.

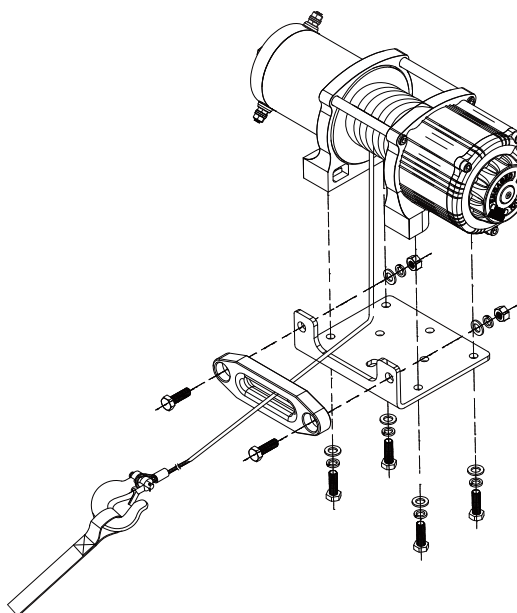

Fig. 2 - Winch mounting

### Step ( 4 )

Secure roller fairlead or hawse ( Fig. 2 ) to mounting plate or structural support using hardware supplied.

**⚠ DANGER** Be sure that both the mounting plate and winch hardware have been properly tightened.

## **WARNING**



**TO PREVENT SERIOUS INJURY FROM EXPLOSION  
DUE TO SPARKING AT THE BATTERY CONNECTION:  
Disconnect the Battery Cables before making other wiring  
connections.**



**TO PREVENT SERIOUS INJURY FROM LEAKING BATTERY ACID:  
Do not use a dirty, corroded or leaking battery.  
Only use a 12V automotive (or equivalent) battery, in good condition.**

1. Plan a route for the wiring from the point of the vehicle where the Winch will be mounted, or used, to the battery. This route must be secure, out of the way of moving parts, road debris, or any possibility of being damaged by operation or maintenance of the vehicle. For example, you may wish to route the wires under the vehicle, attaching it to the frame using suitable fasteners. Do not attach the wires to the exhaust system, drive shaft, emergency brake cable, fuel line, or any other components which may damage the wiring through heat or motion, or create a fire hazard.
2. If you drill through the bumper or any part of the body to route the wires, be sure to install a rubber grommet in the hole to prevent fraying of the wires at that point.
3. Route the cables from the Receiver to the battery and from the Receiver to the Winch, following the precautions discussed earlier.
4. Attach the wires from the Receiver to the terminals on the Winch. Refer to Figure E.
5. Attach the red cable from the Circuit Breaker to the positive terminal on the battery. Refer to Figure E.
6. Attach the long black cable from the Receiver directly to the negative terminal of the battery. Refer to Figure E.

## **Preparing the Wire Rope**

1. The Wire Rope must be properly coiled under tension to be able to support a load without damage.
2. Uncoil the Wire Rope, except for 5 full wraps.
3. Recoil the Wire Rope back into the Winch under at least 500 lb. of tension.



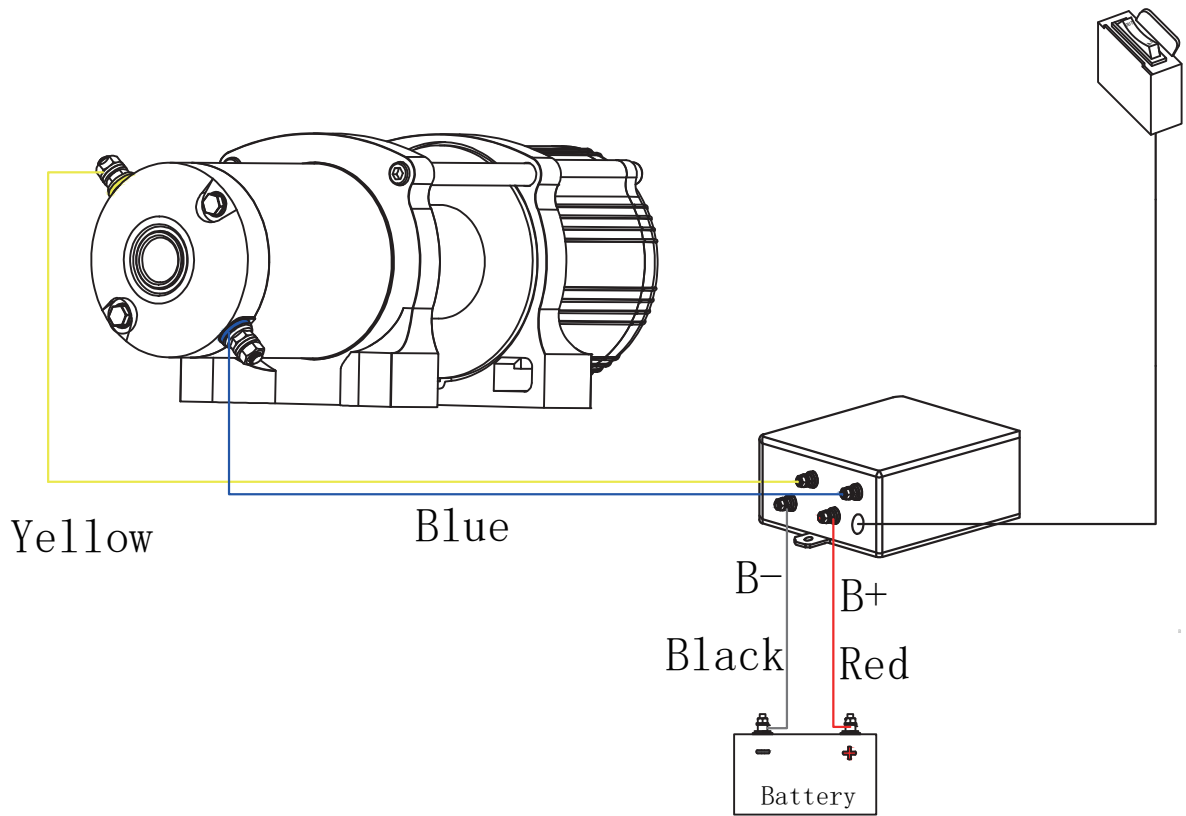

**Figure E: Wiring Connections.**

**Note:** The attachment of the Motor Cables to the terminals on the Winch determines the operation of the Remote's button. After the unit is mounted and powered, check the direction of the Power In and Power Out on the Remote button. To change the direction on the Remote, disconnect the battery cables from the battery, switch the Motor Cable connections on the Motor Assembly, then reconnect the battery cables.

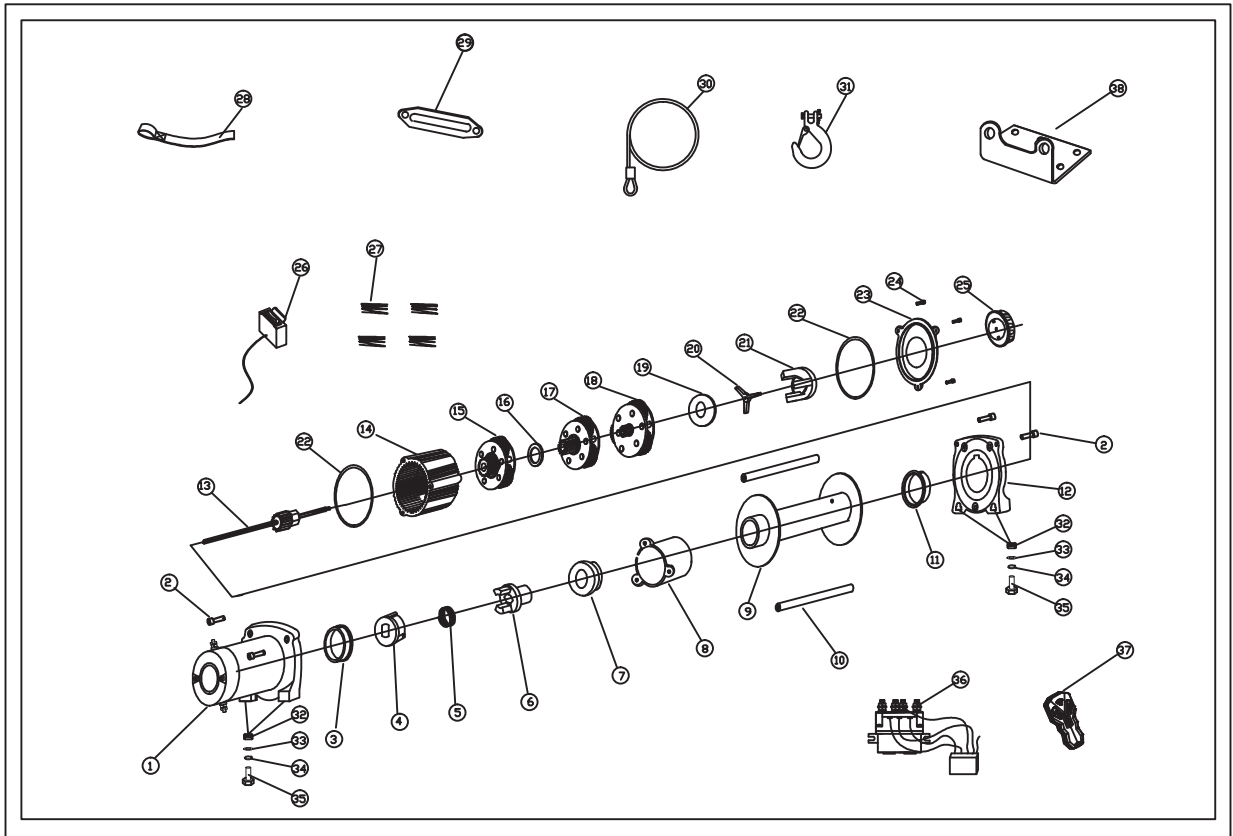

## Parts List

No.	Description	Quantity	No.	Description	Quantity
1	Motor	1	20	Trigeminal piece	1
2	Socket head screw	4	21	Sit of trigeminal piece	1
3	Powder ink bearing	1	22	The oring	1
4	The eccentric sleeve	1	23	The back cover	1
5	Spring brake	1	24	Socket head screw	3
6	Transmission shaft	1	25	Handle	1
7	The clinker set	1	26	Switching line	1
8	Brake block	1	27	Wires	4
9	Drum	1	28	Hook strap	1
10	Supporting shaft	2	29	Aluminm roperack	1
11	Powder ink bearing	1	30	Synthetic rope	1
12	Gear bracket	1	31	Hook	1
13	The sping shaft	1	32	Square nut	4
14	Outside cylinder	1	33	Flat mat	4
15	The first set of star gear	1	34	Spring washers	4
16	Gasket	1	35	Outside the hexagonal screw	4
17	The second set of star gear	1	36	Relay	1
18	The third set of star gear	1	37	Wire less remote	1
19	The clinker cocks	1	38	Mounting plate	1

<b>Problem</b>	<b>Possible Causes</b>	<b>Likely Solutions</b>
Motor overheats.	<ol style="list-style-type: none"> <li>1. Incorrect power cords.</li> <li>2. Winch running time too long.</li> </ol>	<ol style="list-style-type: none"> <li>1. Use only supplied power cords.</li> <li>2. Allow Winch to cool down periodically.</li> </ol>
Motor does not turn on.	<ol style="list-style-type: none"> <li>1. Remote batteries dead.</li> <li>2. Loose battery cable connections</li> <li>3. Vehicle battery needs charging.</li> <li>4. Solenoid malfunctioning.</li> <li>5. Remote damaged.</li> <li>6. Defective motor.</li> <li>7. Water has entered motor.</li> <li>8. Internal damage or wear.</li> </ol>	<ol style="list-style-type: none"> <li>1. Replace Remote batteries.</li> <li>2. Tighten nuts on all cable connections.</li> <li>3. Fully charge battery.</li> <li>4. Tap solenoid to loosen contacts. Apply 12 volts to coil terminals directly. A clicking indicates proper activation.</li> <li>5. Replace Remote.</li> <li>6. Check for voltage at armature port with Switch pressed. If voltage is present, replace motor.</li> <li>7. Allow to drain and dry. Run in short bursts without load until completely dry.</li> <li>8. Have technician service Winch.</li> </ol>
Motor runs but Wire Rope drum does not turn.	Clutch not engaged.	Move the Clutch Handle to the Engaged position. If problem persists, a qualified technician needs to check and repair.
Motor runs slowly or without normal power.	<ol style="list-style-type: none"> <li>1. Insufficient current or voltage.</li> <li>2. Loose or corroded battery cable connections</li> <li>3. Incorrect power cords.</li> </ol>	<ol style="list-style-type: none"> <li>1. Battery weak recharge. Run Winch with vehicle motor running.</li> <li>2. Clean, tighten, or replace.</li> <li>3. Use only supplied power cords.</li> </ol>
Motor runs in one direction only.	<ol style="list-style-type: none"> <li>1. Defective or stuck solenoid</li> <li>2. Remote damaged.</li> </ol>	<ol style="list-style-type: none"> <li>1. Tap solenoid to loosen contacts Repair or replace solenoid.</li> <li>2. Replace Remote.</li> </ol>



**Follow all safety precautions whenever diagnosing or servicing the tool. Disconnect power supply before service.**



**Procedures not specifically explained in this manual must be performed only by a qualified technician.**



**TO PREVENT SERIOUS INJURY FROM ACCIDENTAL OPERATION: Disconnect the Battery Cables before performing any inspection, maintenance, or cleaning procedures.**



**TO PREVENT SERIOUS INJURY FROM WINCH FAILURE: Do not use damaged equipment. If abnormal noise or vibration occurs, have the problem corrected before further use.**

## Cleaning, Maintenance, and Lubrication

---

1. **BEFORE EACH USE**, inspect the general condition of the Winch. Check for:
  - loose hardware
  - misalignment or binding of moving parts
  - cracked or broken parts
  - damaged electrical wiring
  - corroded or loose terminals
  - any other condition that may affect its safe operation.Examine the Wire Rope. Do not use the Winch if the Wire Rope is frayed, kinked or damaged.
2. **AFTER USE**, wipe external surfaces of the Winch with clean cloth.
3. Lubricate the Wire Rope occasionally with a light oil.
4. The Winch's internal mechanism is permanently lubricated. Do not open the housing. However, if the Winch is submerged, it should be opened, dried, and re-lubricated by a qualified technician as soon as possible to prevent corrosion.

## Wire Rope Replacement

---

1. Move Clutch Handle to the released (freepool) position. Refer to Clutch Operation on **Figure F**.
  2. Extend the Wire Rope to its full length, noting how the existing Wire Rope is connected to the inside of the drum.
  3. Remove old Wire Rope and attach new assembly.
- CAUTION!** Do not replace with inferior wire rope. Only use a wire rope rated to the same rating cited on the specification chart or better.
4. Retract Wire Rope onto Wire Rope drum being careful not to allow kinking. Refer to instructions for tensioning the Wire Rope under Preparing the Wire Rope.
  5. Test Electric Winch for proper operation.

## Wireless Remote Control Battery Replacement

---

1. Remove screws from battery cover on back of Wireless Remote.
2. Remove battery cover carefully.
3. Remove used batteries from unit and replace with same. Dispose of used batteries in accordance with all applicable local, state and federal laws

**Note:** Position batteries in proper polarity.

4. Replace battery cover and tighten screws securely.



**Read the ENTIRE IMPORTANT SAFETY INFORMATION section at the beginning of this manual including all text under subheadings therein before set up or use of this product. The instructions that follow are basic guidelines only and cannot cover all situations encountered during use. The operator and assistants must carefully plan usage to prevent accidents.**

## Clutch Operation

---

**CAUTION! Do not adjust the clutch unless there is no load on the Wire Rope.**

1. The position of the pin in the shaft determines whether the clutch is engaged or not.
2. To change clutch positions:
  - a. Pull clutch handle out.
  - b. Turn it 90° while it is pulled out, then release it.

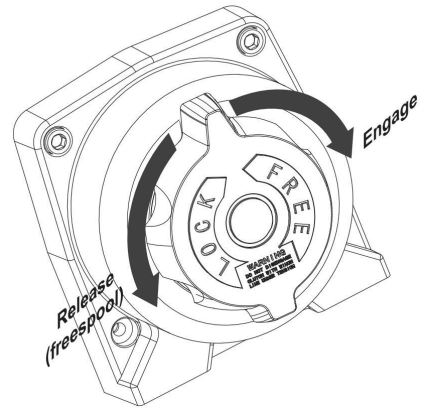

**Figure F: Clutch operation**

## Remote Control Instructions

---

**WARNING!** Only operate the Winch while the Winch, line, and load are in view. Make sure that there are no bystanders nearby.

To prevent serious injury from accidental starting, turn off remote after every use.

## Wired Operation

---

1. To use the Wired Remote Control, connect the Remote Control Cable to the Remote Control Socket on the Receiver. Refer to Figure E.
2. With the Clutch Handle in the Engaged position, press IN on the Rocker Switch to retract the Wire Rope.
3. Press OUT on the Rocker Switch to extend the Wire Rope out.

## Wireless Operation

---

1. Activate the Wireless Remote by pressing the ON/OFF button for 3 seconds until the lights up.
2. Press IN or OUT to operate the Winch.
3. To turn off the Wireless Remote, keep pressing the ON/OFF button for 3 seconds until the lights turns off. The Wireless Remote will automatically power off after 2 minutes of inactivity.

# Double Line Rigging

---

a. A double line system should be used whenever possible. It reduces the load on the Winch, allowing it to work longer with less heat buildup. It reduces load on the Winch in two ways:

- It utilizes the lower layers of wire rope that have higher capacity.
- It halves the load on the Winch through pulley action.

b. Connect the wire rope for a double line system as shown in Figure I below. Use a snatch block (sold separately) properly rated for the load to be pulled and designed to be operated with this Winch's wire rope.



c. Loop the wire rope around the snatch block and connect to another part of the vehicle's chassis or to a separate anchor point. Do not anchor the Wire Rope back to the Winch or winch mount.

**Note:** If anchoring the winching vehicle, only attach the anchor line to the front of the vehicle. If the anchor line is attached to the rear of the vehicle, the vehicle's frame may be damaged by the forces exerted by winching.

**Figure I: Double Line setup**

## **WARNING! TO PREVENT SERIOUS INJURY AND DEATH:**

Operate the Winch only while you have a clear view of the Winch, wire rope and entire winching operation. Stop winching if your view becomes obstructed.

1. Operate the controls briefly to ensure they work properly.

a. For the Wired Remote Control:

- The IN position should retract the winch cable.
- The OUT position should power out the cable.

b. For the Wireless Remote Control:

- Activate the Wireless Remote by pressing the ON/OFF button for 3 seconds until the lights up.
- The IN button should retract the winch cable.
- The OUT button should power out the cable.

If operation is reversed, the power cables may be connected backwards. Correct any such issue before use.

2. When it is safe to do so, use the power switch on the Controller to retract the Wire Rope, and winch the item as desired. Do not power the hook all the way into the fairlead to prevent damage.

3. Do not operate the Winch at extreme angles. Do not exceed the angles shown in Figure B for a roller fairlead. For a hawse fairlead, the angle should be as close to straight as possible.

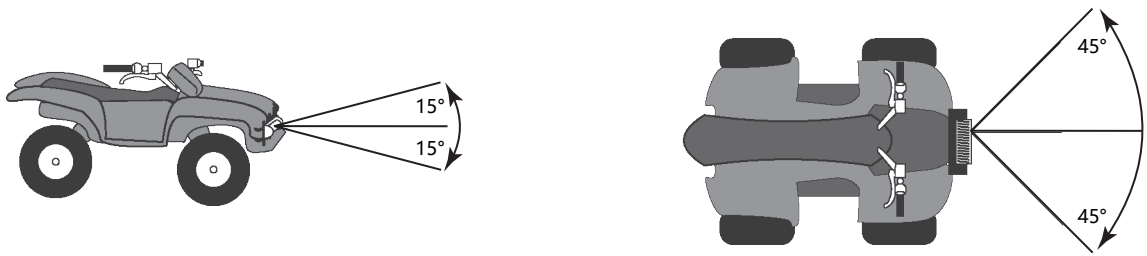

**Figure B: Roller Fairlead Maximum Winching Angles**

4. If the object to be pulled must be pulled at an angle in relation to the Winch, use a snatch block (sold separately) and an anchor point directly in front of the Winch, as shown in Figure C, to keep the Wire Rope pull straight.

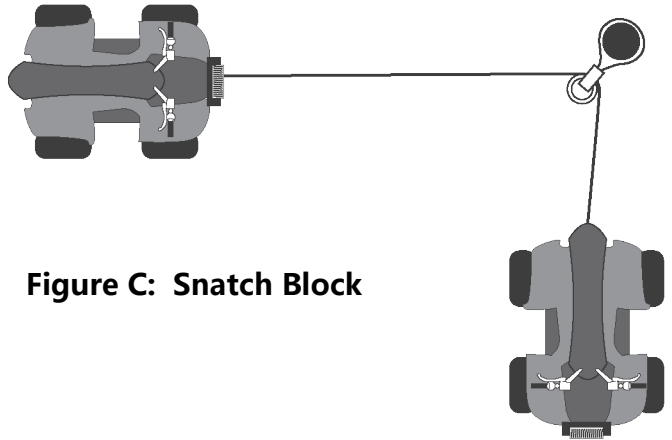

**Figure C: Snatch Block**

5. **WARNING!** Stop the Winch and release tension on the Wire Rope before moving the blanket or winch damper placed on it.

6. Do not continue use of the Winch until the battery is completely run down.

7. When possible, keep the engine running while using this Winch, to continually recharge the battery and prevent the battery from being drained so much that the vehicle cannot start. However, exercise extreme caution when working around a running vehicle and **ONLY** operate a vehicle in an outdoor area.

**CAUTION!** *Do not use the Winch in a constant duty application, it is designed for INTERMITTENT USE ONLY Keep the duration of the pulling job as short as possible. If the motor becomes very hot to the touch, stop and let it cool down for several minutes. Do not pull for more than one minute at or near the rated load. Do not maintain power to the Winch if the motor stalls. Double Line Rigging will help prevent overloading and should be used whenever practical. See Double Line Rigging on page 11.*

8. When finished pulling the load, reverse the direction of the Winch just enough to release tension on the Wire Rope so that you can unfasten the Hook from the load and reel in the Wire Rope.

**CAUTION!** *Do not power the Hook all the way into the Fairlead to prevent damage.*

9. Press and hold the ON/OFF button on the Wireless Remote for 3 seconds to turn the Remote off. The indicator light on the Remote will turn off.

10. If using the Wired Remote Control, disconnect the Remote Control Cable from the Remote Control Socket on the Receiver after use.

**WARNING!** *To prevent serious injury from accidental operation, disconnect the red Circuit Breaker cable from the positive terminal on the battery after use.*

## Duty Cycle (Duration of Use)

Avoid damage to the Winch by not winching for more than the prescribed duty cycle time.

The Duty Cycle defines the amount of time, within a 15 minute period, during which a

Winch can operate at its maximum capacity without overheating. For example, this Winch with a 5% duty cycle at its maximum load must be allowed to rest for at least 14 minutes, 15 seconds after every 45 seconds of continuous operation. Failure to carefully observe duty cycle limitations can easily over-stress a Winch contributing to premature Winch failure.

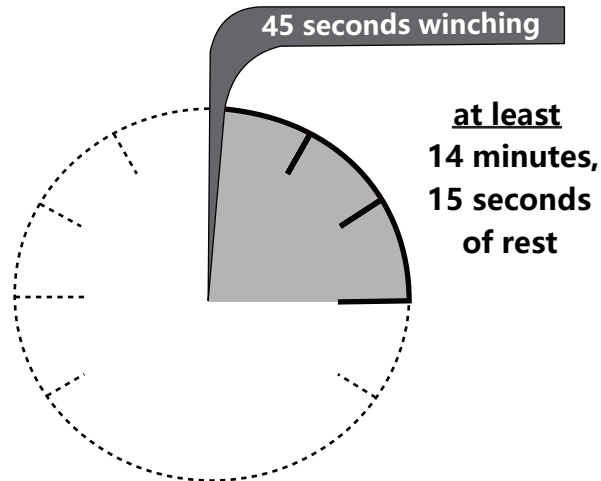

### FCC STATEMENT

Caution: The user is cautioned that changes or modifications not expressly approved by the party responsible for compliance could void the user's authority to operate the equipment.

This device complies with Part 15 of the FCC Rules. Operation is subject to the following two conditions: (1) this device not cause harmful interference. (2) this device must accept any interference received, including interference that may cause undesired operation.

Note: This equipment has been tested and found to comply with the limits for a Class B digital device, pursuant to Part 15 of the FCC Rules. These limits are designed to provide reasonable protection against harmful interference in a residential installation. This equipment generates, uses and can radiate radio frequency energy and, if not installed and used in accordance with the instructions, may cause harmful interference to radio communications. However, there is no guarantee that interference will not occur in a particular installation.

If this equipment does cause harmful interference to radio or television reception, which can be determined by turning the equipment off and on, the user is encouraged to try to correct the interference by one or more of the following measures!

- Re-orient or relocate the receiving antenna.
- Increase the separation between the equipment and receiver.
- Connect the equipment into an outlet on a circuit different from that to which the receiver is connected.
- Consult the dealer or an experienced radio/TV technician for help